

TVA PMU Real Time Application Uses

Real Time Oscillations Monitoring

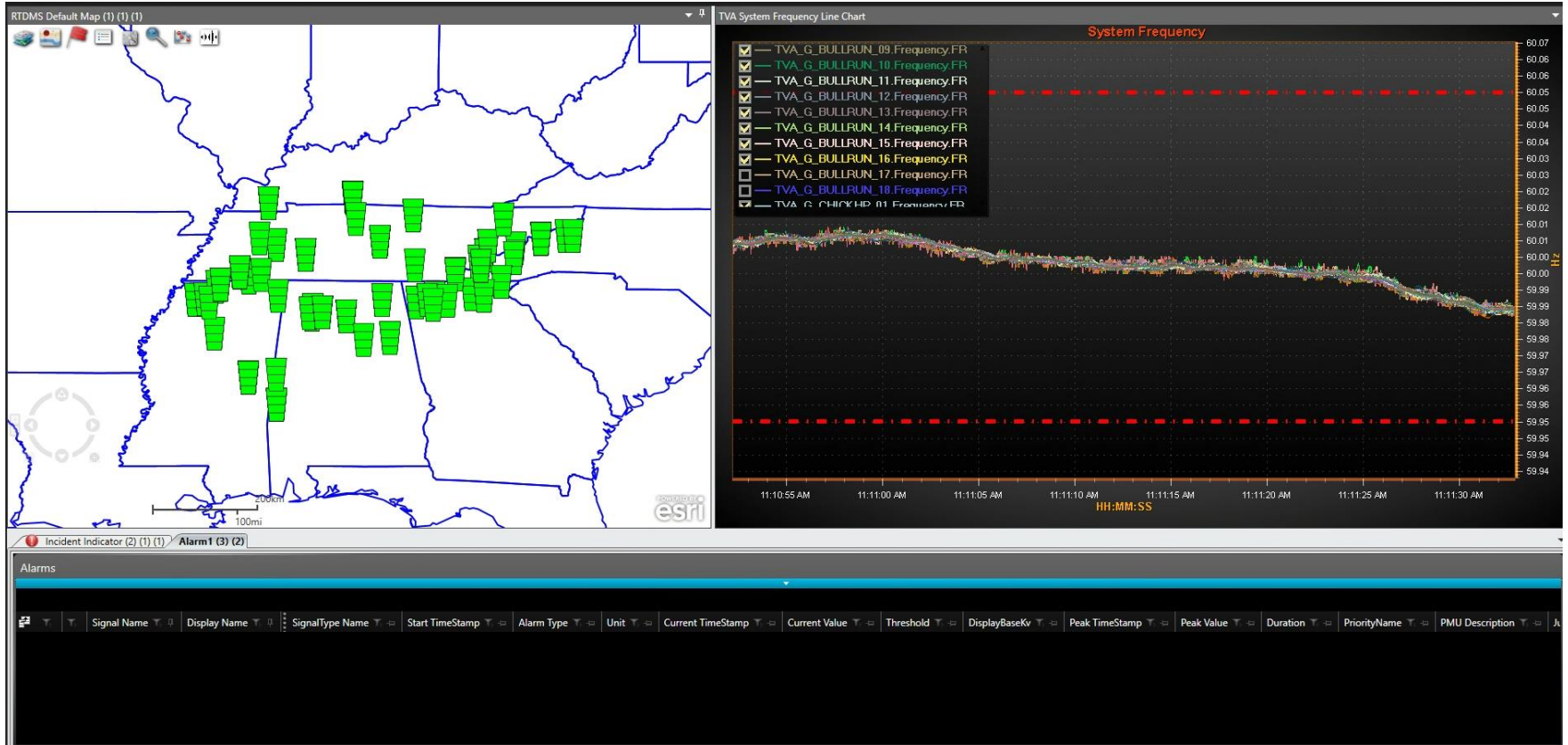

Real Time Oscillation Event with no Alarms

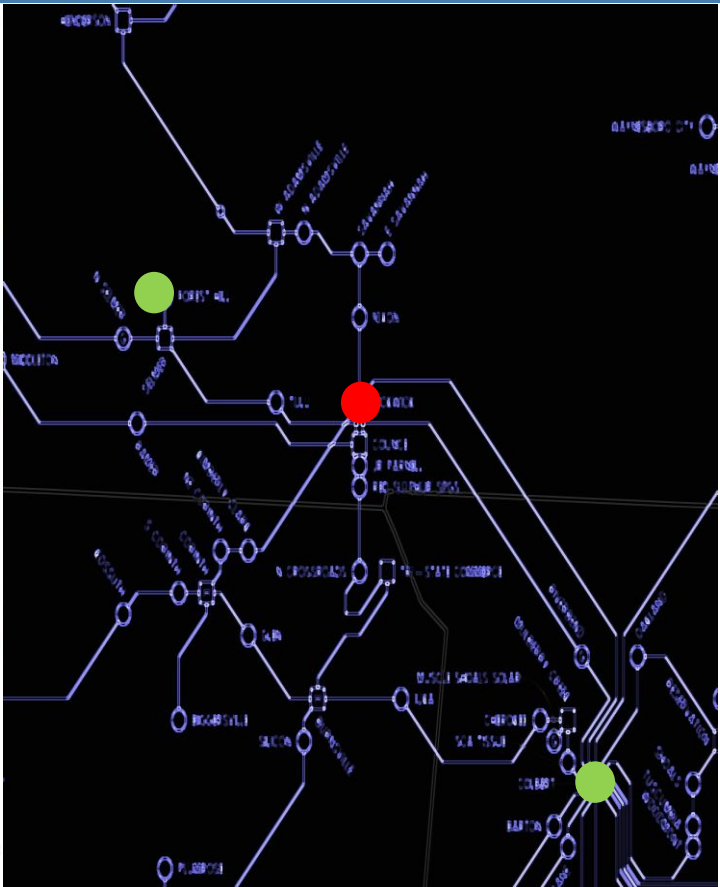
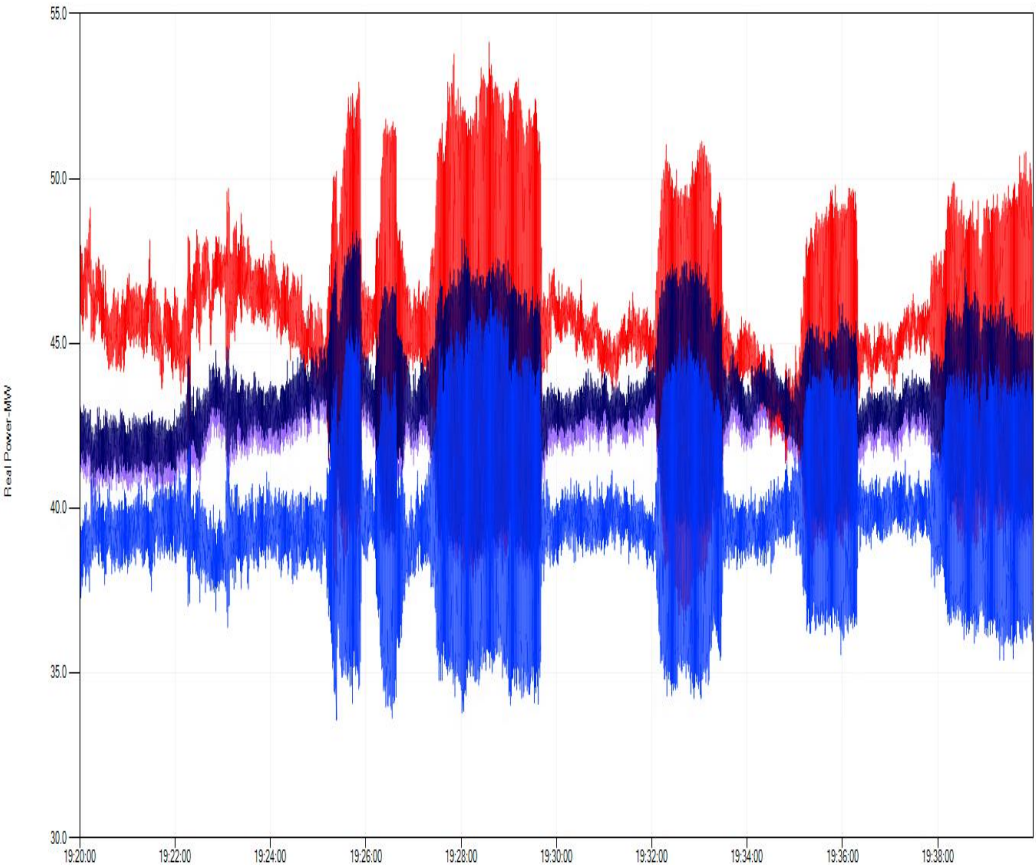

IBR Commissioning and Monitoring

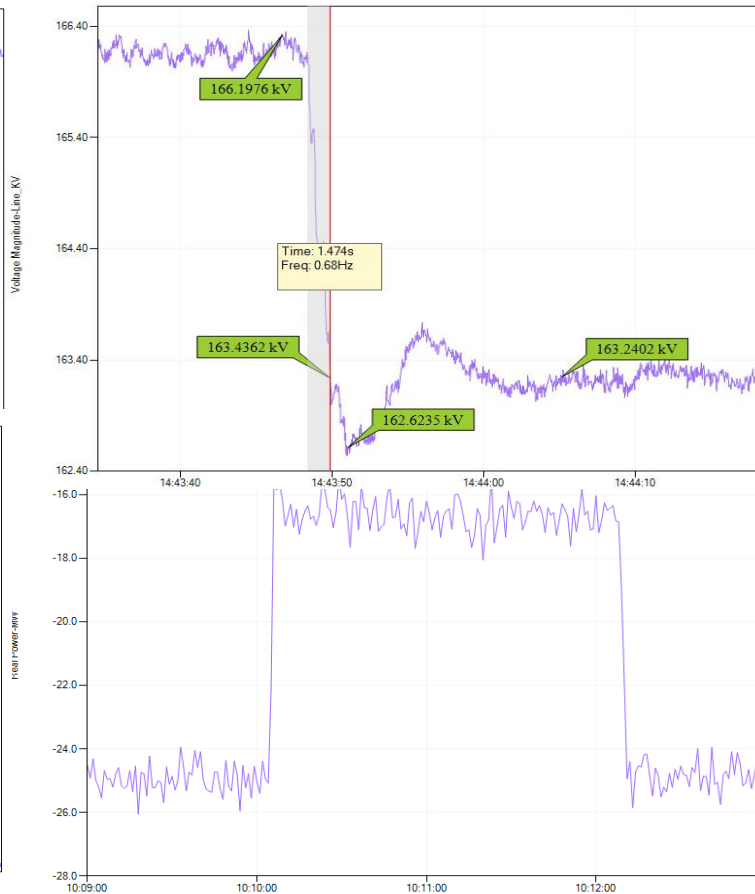
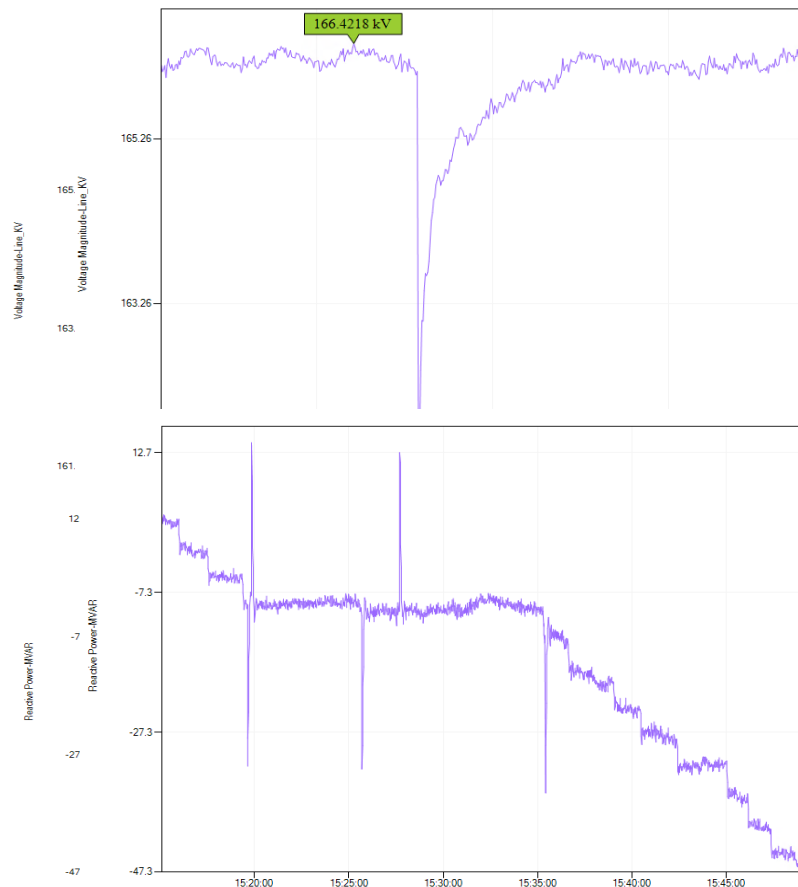

Real Time System Testing



Real Time One Line Diagrams

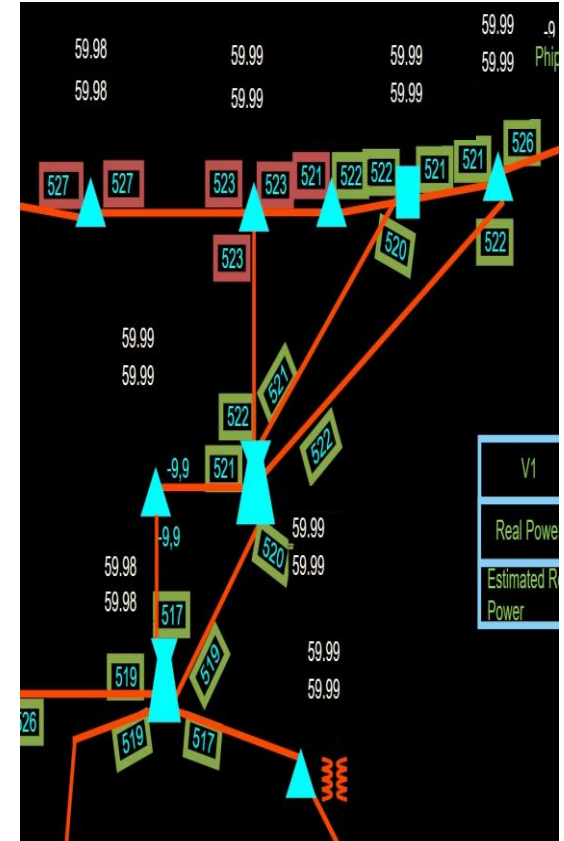
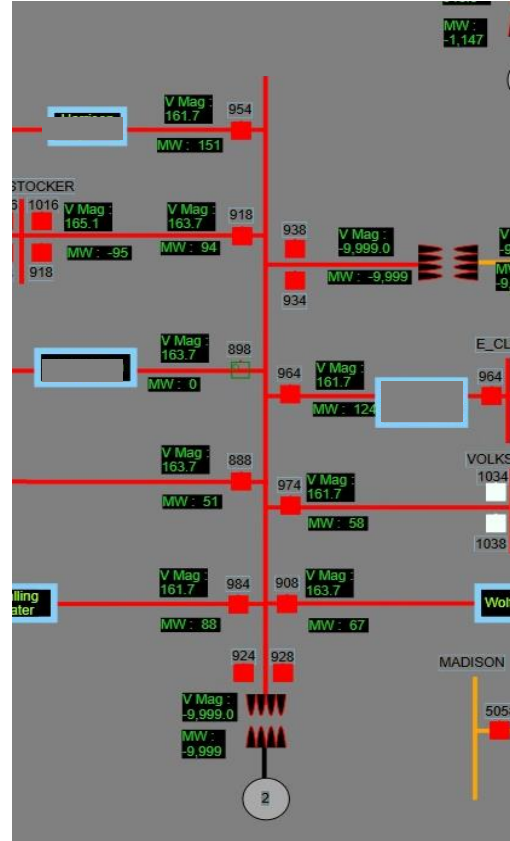
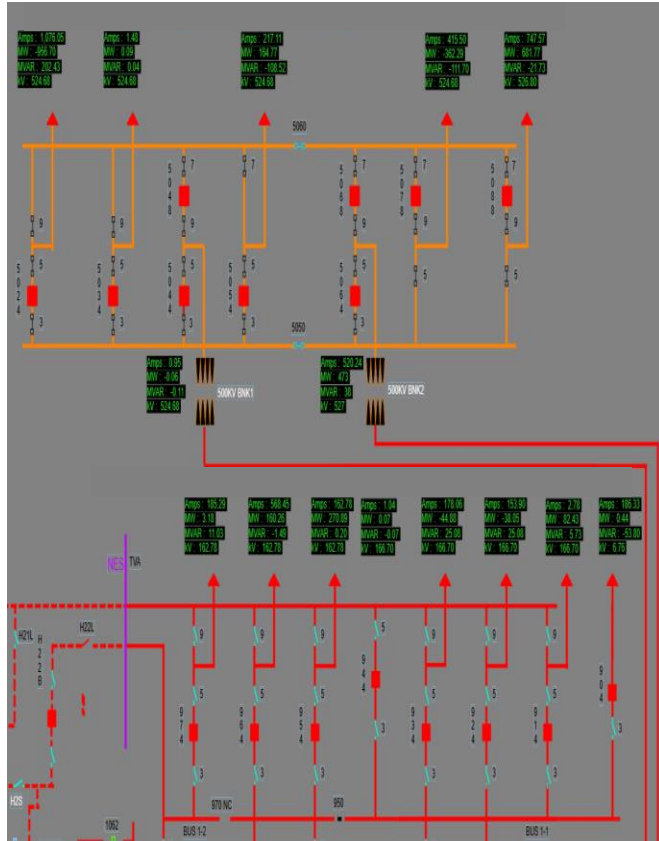

TVA PMU Post Event Analysis

MW and MVAR Oscillations due to equipment issues

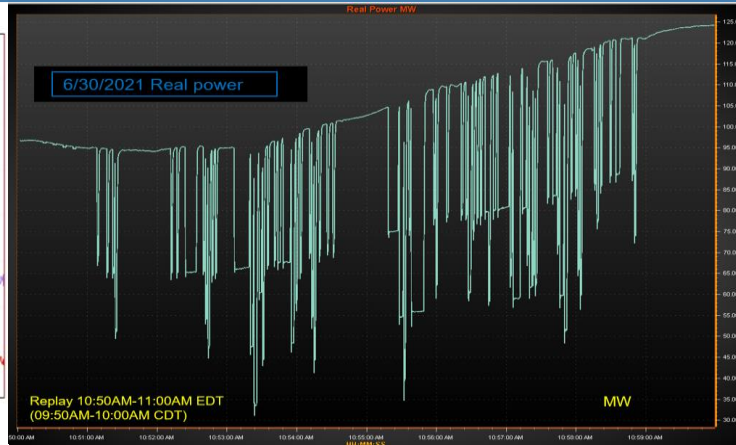
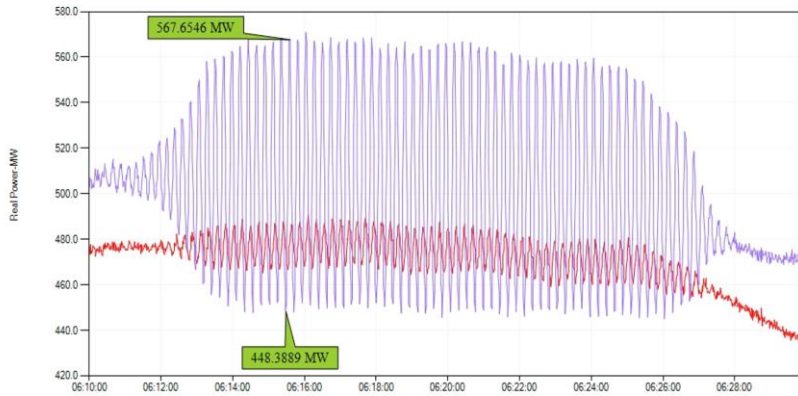

Visualizing High Speed Large Scale Events

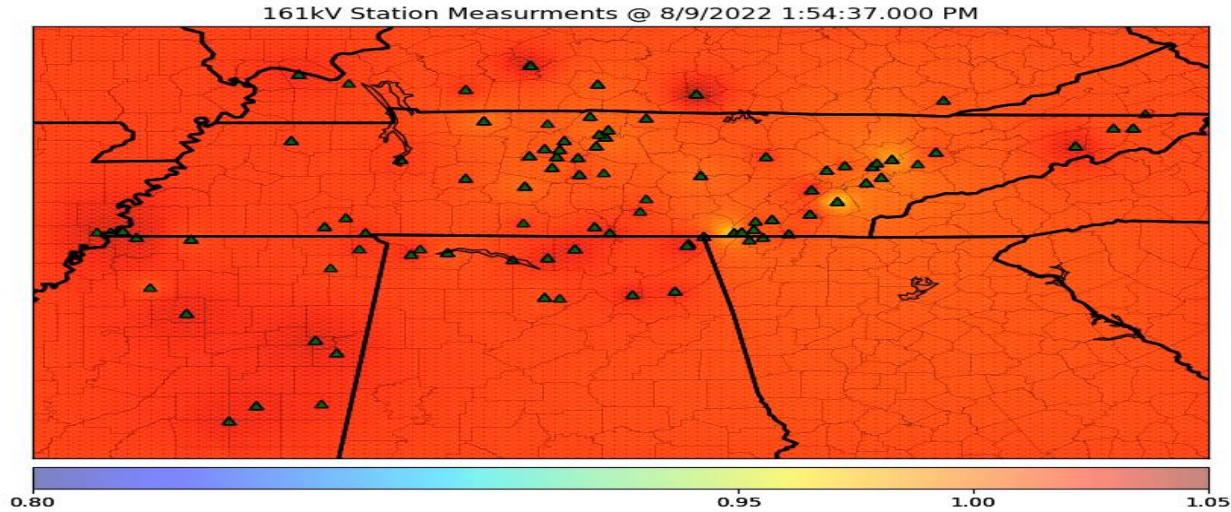

Investigating Events

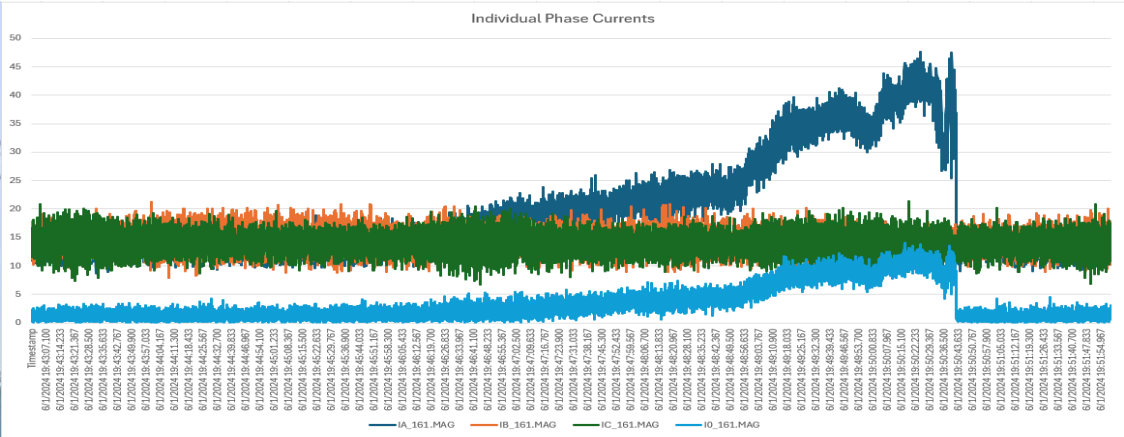

Post Commissioning issues with IBRs

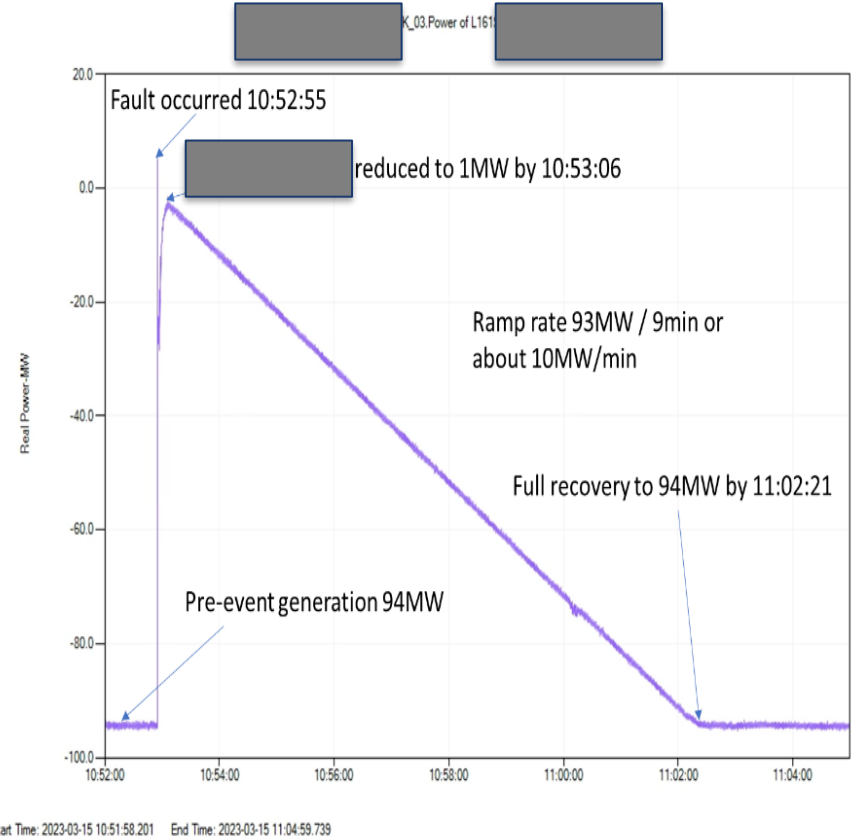
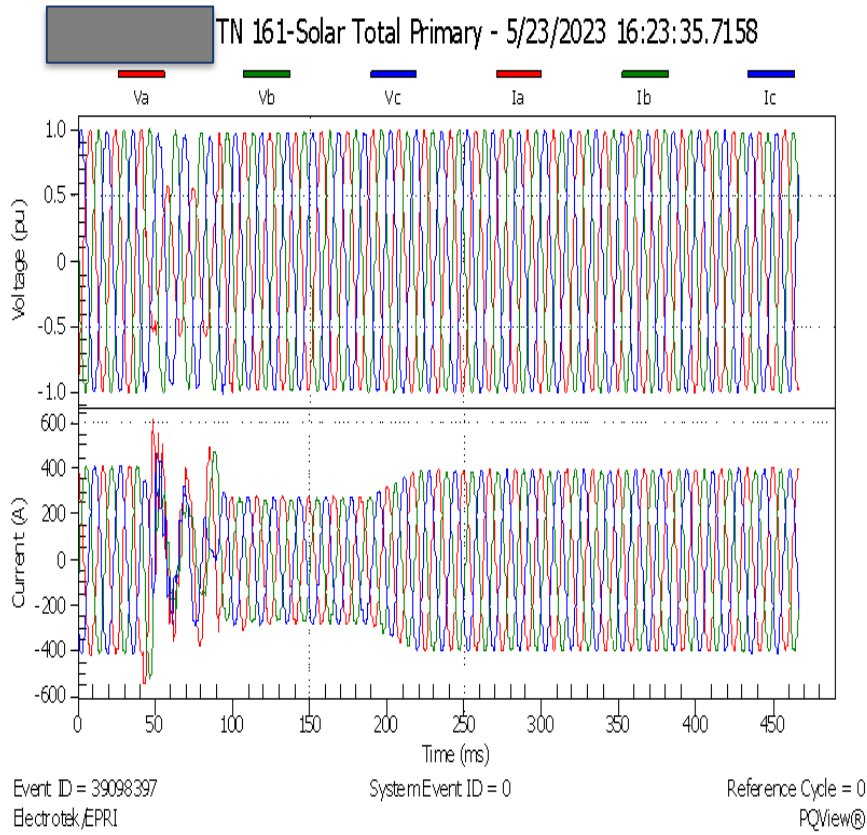

TVA PMU Planned Uses

Unbalance Current Monitoring

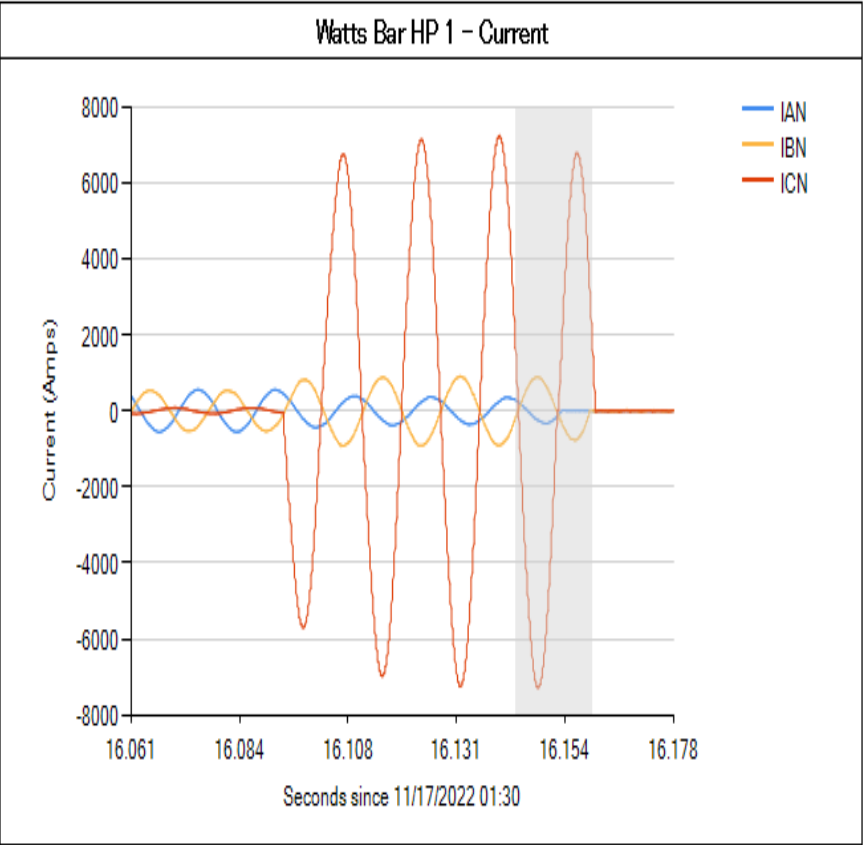

Voltage Unbalance Monitoring

V2/V1 PMU Data For Failing and Normal VT

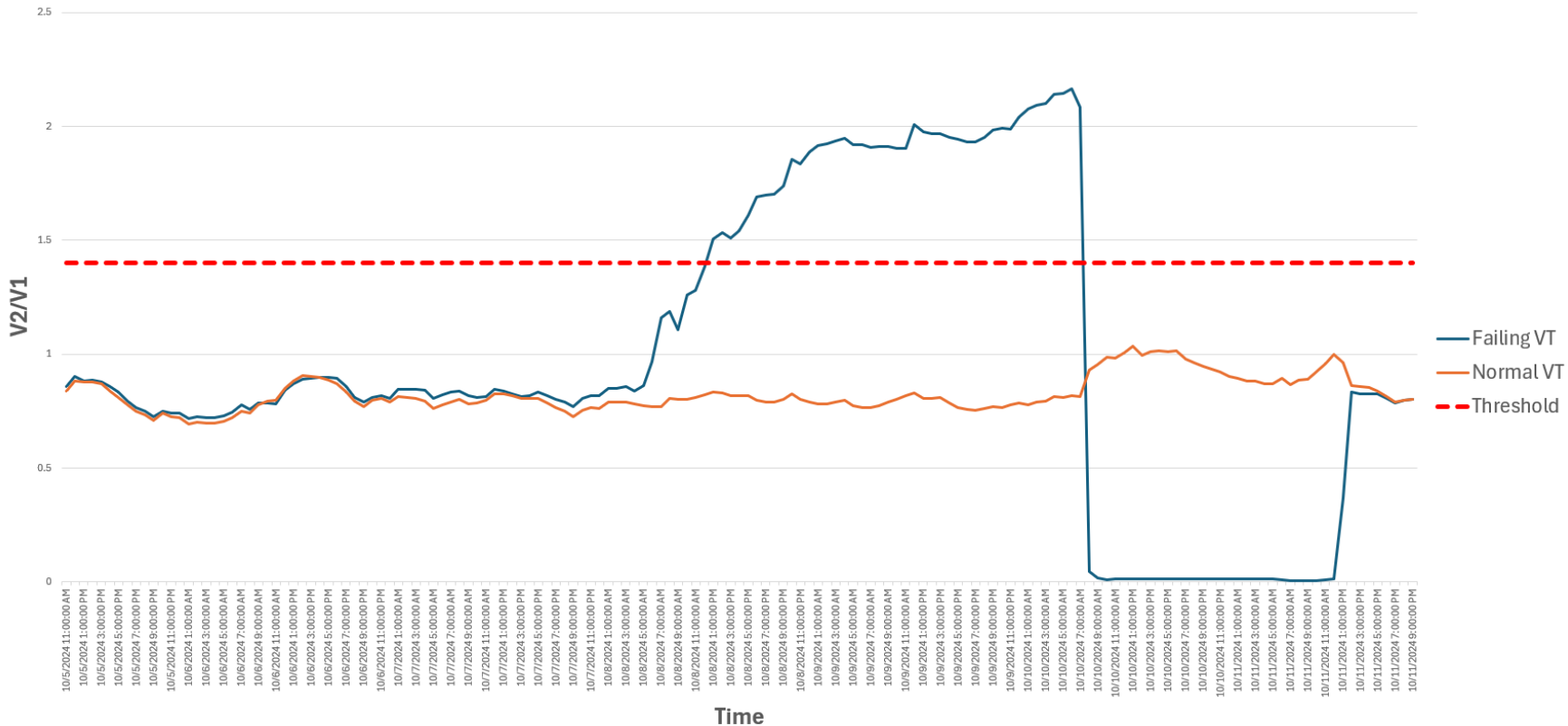

Islanding Detection

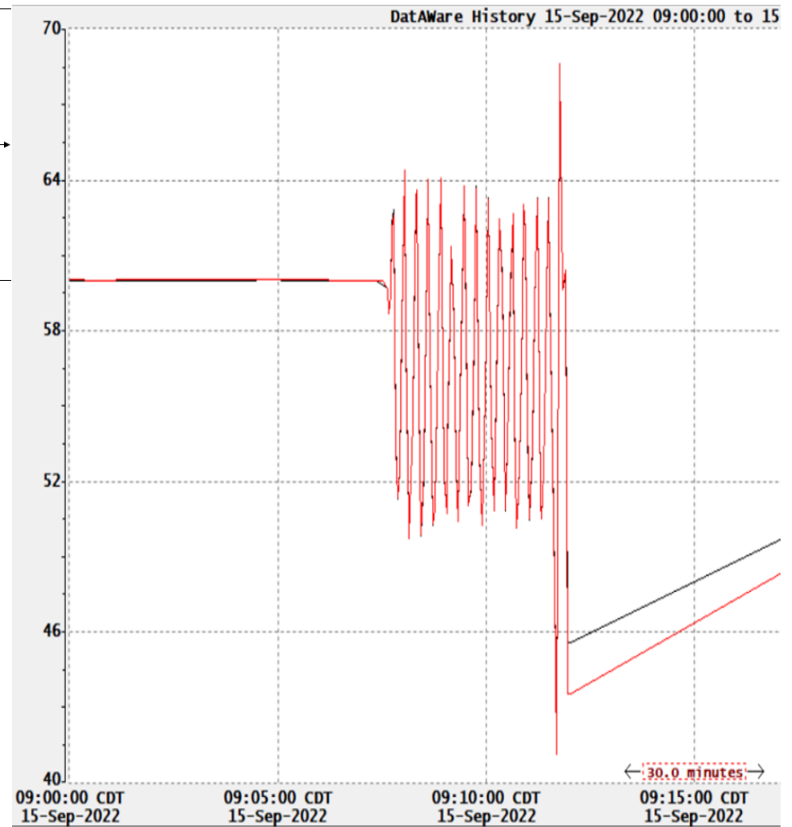
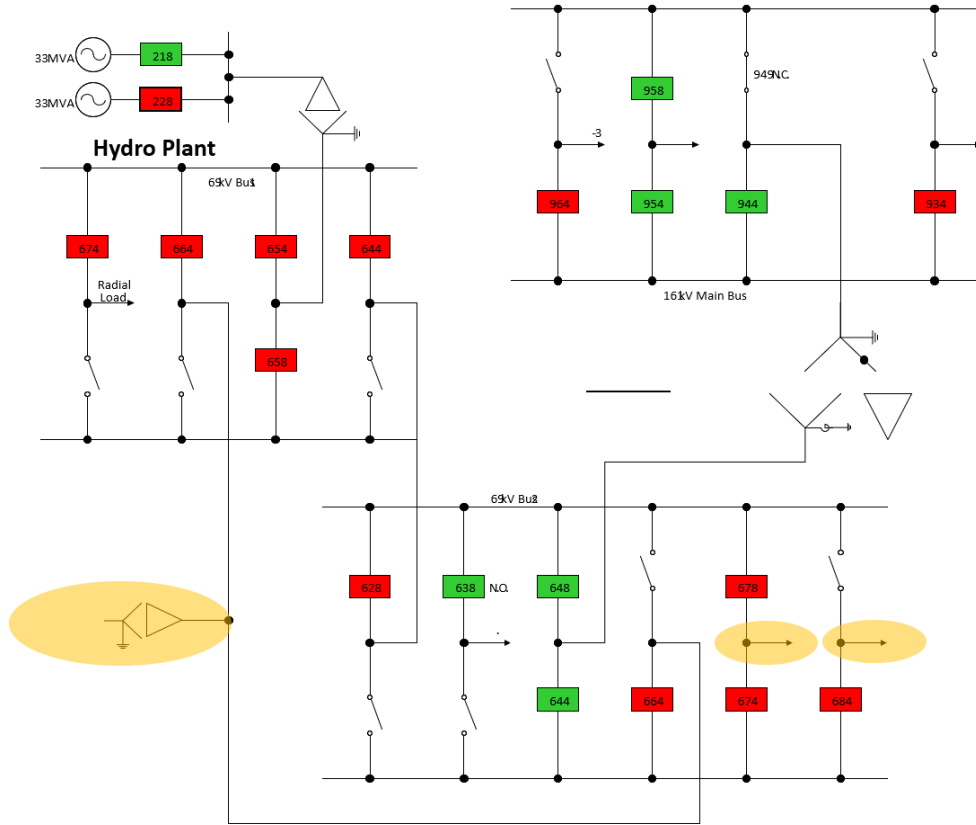

TVA

**TENNESSEE
VALLEY
AUTHORITY**